

THE USE OF SYSTEMATIC LAYOUT PLANNING AND ARENA SOFTWARE TO IMPROVE MANUFACTURING LAYOUT



Muhammad Marsudi

THE USE OF SYSTEMATIC LAYOUT PLANNING AND ARENA
SOFTWARE TO IMPROVE MANUFACTURING LAYOUT

Author:

Dr. Ir. Muhammad Marsudi, M.Sc.

ISBN: 978-623-7583-32-5

Editor:

Yassyir Maulana, ST., MT.

Cover Design and Layout:

Hana Aghnia R.

Publisher:

Universitas Islam Kalimantan Muhammad Arsyad Al Banjari
Jl. Adhyaksa No. 2 Kayutangi, Banjarmasin 70123

First Printed in 2020

Copyright is protected by law. No part of this work may be reproduced or utilized in any form or by any means, electronic or mechanical, including photocopying, recording or by any information storage and retrieval system, without the prior written permission of the publisher.

FOREWORD

Problems in the manufacturing system, especially related to the layout or the production process in a factory is very important to understand. The production process itself is usually a process that is interconnected between one machine to the next so that raw material which is input can be used as output in the form of finished goods that have more added value than the input. Therefore, if the placement of production machines is not regulated as well as possible, it will result in an ineffective and inefficient production process. To prevent these unfavorable layouts the use of Systematic Layout Planning (SLP) will be able to help resolve these problems. The use of SLP accompanied by the use of ARENA simulation software will be discussed in this book. The author hopes that this book will add insight to readers in general and especially to readers from manufacturing industry practitioners and Industrial Engineering Students in tertiary institutions. Finally, suggestions from readers for the improvement of this book are the authors' hopes. Thanks.

CONTENT

	Page
TITLE AND COPYRIGHT STATEMENT	ii
FOREWORD	iii
CONTENT	iv
LIST OF TABLES	vi
LIST OF FIGURES	vii
CHAPTER I INTRODUCTION	1
1.1 Study background	1
1.2 Problem Statement	3
1.3 Objective of Study	3
1.4 Scope of Study	3
1.5 Importance and Significance of Study	4
1.6 Expected Results	4
1.7 Conclusion	5
CHAPTER II LITERATURE REVIEW	6
2.1 Introduction	6
2.2 Cycle Time	6
2.3 Review Motion (Motion Study)	7
2.4 Cycle Time Reduction	10
2.5 Management and Reducing Cycle Time	12
2.6 Quick Response	13
2.7 Layout Facilities	15
2.8 Layout Problems	15
2.9 Factors Affecting Layout	16
2.10 Advantages of Good Layouts	17
2.11 Types of Layouts	17
2.11.1 Process layout	17
2.11.2 Product layout	18
2.12 Systematic Layout Planning (SLP)	19
2.13 ARENA Software	21
2.14 Conclusion	21
CHAPTER III METHODS OF STUDY	22
3.1 Introduction	22

3.2	Research Methods	22
3.3	Workflow	23
	3.3.1 Literature review	24
	3.3.2 Identifying the factory	24
	3.3.3 Data collection	25
	3.3.4 Analyzing data	25
3.4	Layout Interpretation Using ARENA	27
	3.4.1 Startup layout	28
	3.4.2 Model description	28
3.5	Conclusion	40
CHAPTER IV	RESULTS AND DISCUSSION	41
4.1	Introduction	41
4.2	Observation Results	41
	4.2.1 Process flow	42
	4.2.2 Process time	44
4.3	Systematic Layout Planning	46
4.4	Building Requirements	51
4.5	Selection Layout	52
4.6	Simulation and Evaluation Using ARENA	56
	4.6.1 ARENA simulation	56
	4.6.2 Original layout results	59
	4.6.3 Alternative layout results	60
	4.6.4 Output at each layout	62
4.7	Cycle Time Analysis	64
4.8	Suggestion	69
4.9	Conclusion	69
CHAPTER V	Conclusions of the Study	70
5.1	Introduction	70
5.2	Final Conclusions	70
REFERENCES		72

LIST OF TABLES

No. Table		Page
3.1	Process flowchart	29
4.1	Process description	42
4.2	Time for each process	45
4.3	<i>Expression</i> per layout	45
4.4	Number of lot size per week	47
4.5	The distance between each section	48
4.6	Total distance	48
4.7	Relationships between activities	49
4.8	Requirements existing space	52
4.9	The comparison of distance-expression among layouts	55
4.10	Original layout simulation results	59
4.11	Results of original layout and alternative layouts	60
4.12	The cycle time differences among three layouts	68
4.13	Output differences among three layouts	68

LIST OF FIGURES

No. Figure		Page
2.1	Continuous stopwatch	9
2.2	Snapback stopwatch	9
2.3	Process layout	18
2.4	Product layout	18
2.5	Product layout/U-shape	18
2.6	Eleven steps Muther's Systematic Layout Planning	20
3.1	Flowchart methodology	24
3.2	Diagram of the relationship between activities	26
3.3	REL chart	27
3.4	Arena view	27
4.1		50
4.2	Relationship among area by using REL-chart	51
4.3	Layout overview using REL	53
4.4	The actual layout of the factory.	53
4.5	Alternative layout 1	54
4.6	Alternative layout 2	56
4.7	Computer hard disk production model	57
4.8	A complete summary of the original layout process	57

4.9		58
4.10	Performance indicators for the original layout	62
4.11	SIMAN results	63
4.12	Performance indicators for alternative layout 1	63
4.13	Time per process for alternative layouts 1	64
	Performance indicators for alternative layout 2	
	Time per process for alternative layouts 2	

ABSTRACT

Cycle time is the time required to complete an operating cycle. This study focuses on the computer hard disk production in a studied company. The study includes the research of cycle time for each process in blanking. The time involved in quantifying the cycle time is the waiting time, processing time, maintenance time, and inspection time. After all, values were recorded for the relevant time; the cycle time value obtained was 74.02 sec. The reading was based on values recorded in the original layout at the studied industry factory. To fulfill the objectives of this study, a systematic layout planning (SLP) approach was performed to obtain a shorter total cycle time. The layout of plants affects the cycle time involved in producing a product. This study continues to examine the layout of the existing system in the production department, analyzing the production layout systems, propose a new production layout, and using Arena software to assess the new layout. Arena software is a modern approach to solve the layout problem without making physical changes to the original layout, but only use the simulation to shows its effectiveness. Indirectly, the Arena software consumer can find the time, output, cost, and utilization in the production workflow. In this study, the Arena software approach is successfully proved that the cycle time taken for alternative layout 2 is shorter than the original layout where 48.85

sec for alternative layout compares to 74.02 sec for the original layout. The total output in the alternative layout also showing a great increase which is 1080,000 pieces hard disk per month compared to 720,000 pieces hard disk per month in the original layout. Therefore, the second alternative layout was chosen as the new layout in this study to reduce the cycle time in the hard disk production line.

CHAPTER I

INTRODUCTION

1.1 Study Background

More than 40 countries with multinational companies such as United States, Australia, Belgium, and Denmark have invested in over many projects in Indonesia's manufacturing sectors. This is because Indonesia's attractive environment, and this has proven that the country can become one of the world's leading locations for offshore manufacturing activities.

All organizations have their own goals and objectives. It can be said that all business organizations have the same goal to maximize their investment. Among the factors that need to be emphasized in the industry other than productivity, quality, job scheduling, job review, ergonomics, and facility planning is the cycle time needed to produce a product.

Cycle time is the sum of the processing time for each step taken to complete a product. The efficiency of the production process depends on time study. Standard time is a modern technique for motion studies that study the same motion and times. Reducing cycle time will ensure more efficient production and increased productivity. Cycle time is the total amount of time from start to finish as determined by the company and the customer. Cycle time consists of the processing time, from the start of the

raw material receipt, and the time taken this raw material goes through several other processes before it is fully completed.

Reducing cycle time can speed up the production and delivery of products to customers faster and at a lower cost. In other words, the management of processing order within a company plays an important role and provides long-term benefits to the company.

There are a few things to consider in a factory setting such as production and flow processes, material handling methods, equipment requirements, growth plans, capacity planning, and management. The design and arrangement of machinery or machines are important because they optimize efficiency and also help workers to handle work in a controlled, fast, and comfortable manner. The main objective of the factory layout is to make the product production process run more smoothly, systematically, and to reduce processing time.

This study focuses on the usefulness of cycle time study as it plays an important role in the production of a product. Cycle time is divided into several categories:

- a. Manual cycle time. Comprising of manual processing time such as unloading, installing man-made without a machine-assisted machine.
- b. Cycle time. Time is taken by a machine during operation.
- c. Automatic cycle time. Time is taken by machine without must be set up by the operator.
- d. Overall cycle time. The total time is taken to produce one unit. Often this type of cycle is studied for a machine or process only.

- e. Total cycle time. This includes the total time for a single product to be completed. This takes into account the process by machine or manual from start to finish.

1.2 Problem Statement

It is difficult for an engineer to evaluate the speed of operation of a machine and at the same time reduce the scaling and keep the production level in good condition. Thus, simulation applications from ARENA will help analyze any improvement activities needed in the production process. The simulation model will present data on time and product performance that are difficult to calculate manually. The data from the simulation will be used in two different interests namely productivity improvement and process utilization. In enhancing the company's productivity, this study will present data to reduce cycle time. This study can suggest an effective production that will increase the value of the product through each input entity and also to suggest a better process planning.

1.3 Objectives of Study

- a. To study the cycle time of production hard disk computer.
- b. To study and understand the flow of each process in the production of hard disk computer.
- c. To make evaluation based on both systematic layout planning (SLP) and simulation of layout using ARENA software (student version).

1.4 Scope of Study

- Identify and analyze processes and other aspects of production hard disk computer.
- Study, create and simulate models using ARENA software. At the end of the simulation, the results will be compared between all layouts based on output and cycle time.
- Time data is taken using a stopwatch.

1.5 Importance and Significance of Study

In today's competitive market, manufacturing excellence is critical to achieving success. This study aims to study key elements of the manufacturing strategy, the ability to compete over time, and to find the key steps in the development of the strategy. The short cycle time can be described as high customer satisfaction over the timely service provided by a production company. The importance of the study cycle time are:

- a) Study of time can help the plant to reduce the cycle time taken for the production of a product.
- b) Productivity in a plant can be increased if further research is done to reduce the processing time.
- c) Study cycle time can increase profitability to a certain company.
- d) Customers are more satisfied because of faster product development time.

1.6 Expected Results

From the data obtained, this study is expected to reduce the cycle time of each process and increase company productivity. The

data obtained will be used and applied as a suggestion to the studied industry to improve its company. From this study, it is hoped that the plant will be better to be understood and emphasize the systematic layout to reduce cycle time while increasing the company's output.

1.7 Conclusion

This chapter discusses the introduction of the study including the background of the study, the problem statement, the objective of the study, the scope of the study, the importance and anticipation of the results of the study to be undertaken. Studies on the cycle time are made and factors that influence the time taken will be identified before any improvements can be made to shorten the cycle. The systematic layout planning (SLP) approach will be used as one way to shorten the cycle time in production.

In the next chapter, it will discuss previous studies related to this conducted study. There are a few things to discuss to help this study to achieve its main objectives.

CHAPTER II

LITERATURE STUDIES

3.1 Introduction

To understand this study in more detail, the literature review plays an important role in seeking out previous sources related to the subject of this study. This whole chapter deals with topics such as cycle time, motion study, cycle time reduction, layout planning, types of layouts, layout issues, SLP approaches, sequences Muther's SLP, quality function usage, and also ARENA software.

3.2 Cycle Time

Cycle time according to Q-Finance, that is a firm of financial resources, is defined as "the period required to complete one cycle of operation, or completing an event, business, or service. Cycle time is used to distinguish the entire time of a process from the time of its production.

According to PCMag Encyclopedia, cycle time refers to the time taken to produce a product to market from the beginning of the process to the end of production. Cycle time includes processing time, moving time, wait time, and check the time. Time category can be defined as follows:

1. Processing: the time taken to complete the process without any additional work.
2. Waiting: the time is taken to wait for another process to take place.
3. Moving: the time taken for shipment work.
4. Customization: the time it takes to do any modification.

5. Checking: the time taken to perform inspections or tests to work.

3.3 Review Motion(Motion Study)

Movement and study time help management determine what products are produced by workers in a specific period. Therefore, it is easier to predict the work schedule and output of production. Motion and Time Study is a scientific method designed by two individuals for the same purpose of increasing productivity and reducing unit costs. Frank B. Gilbreth has created a *motion study* to determine the best path for a complete job. Frederick W Taylor has conducted a time study in which he measures how much time a worker takes for a full-time job.

Frank and Lillian Gilbreth have used camera footage to see how the work moves in preparation for a process. This makes it easier for them to make improvements to these processes. Time and motion studies have been used separately in the past, but at the moment, both are necessary because they have a strong connection.

Frank B Gilbreth introduced his ideas in the study of movement through bricklaying in his work in 1885. He began to observe the workings of bricklaying workers by recording them. After the brick was laid, he noticed that workers began to examine the brick to see if it was compatible with other bricks. He later suggested that the workers make a classification of the bricks first before the excavation works. With this method, the time required to settle is shorter.

Frederick W. Taylor used a stopwatch and a piece of a clipboard to record the time of his study. She began her research

with her own family by recording the time they spent completing activities around the house.

According to Frederick W.Taylor, the study of time using the stopwatch is the most common technique for standard production time in manufacturing. Timing standards are the most important element for obtaining manufacturing information, and the use of stopwatch time is the only way that management and employees agree. The study of the stopwatch was developed in the 1880s and was the first technique used to set the standard time.

Manufacturing companies have found that they can use time and motion research to grow their business in a variety of ways. The manufacturing industry uses motion and time studies to reduce wasted time and improve time for one complete task. Today, every business such as manufacturing, the warehouse also emphasizes motion and time study methods to reduce costs and help achieve their sales goals.

Using a stopwatch in the study of motion and time study is the most effective method in studying any time for a process in the industrial field. In this study to identify the cycle time, two types of stopwatch will be used namely continuous stopwatch and snapback stopwatch.

a) Continuous stopwatch.

A continuous stopwatch is used for recording time continuously. This method will be used to derive the operating time value of a machine. The use of continuous stopwatch allows time to be taken continuously from start to finish.

b) Snapback stopwatch.

Snapback stopwatch ideally is used to get repeated readings on a single process. The principle of this snapback stopwatch is that the readings are returned to zero value that means the second readings are ready to be taken. The use of a snapback stopwatch is easier than a continuous stopwatch as it is easier and faster to record time.



Figure 2.1. Continuous stopwatch



Figure 2.2. Snapback stopwatch

3.4 Cycle Time Reduction

Philips Thomas states that, according to his study, by reducing cycle time, the quality of a mill will increase. Rapid

production allows for low inventory levels, as well as exposing weaknesses and increasing rates of change. After eliminating all unnecessary values or steps, defects in the production process can be minimized. The fast and fast process allows for a continuous supply chain. Besides, customers will also trust the manufacturing company as well as strengthen business relationships.

According to Philips, cycle time is the time required to complete a process. The cycle time may start with a phone call from the customer, followed by the request process and ending with an order including delivery to the customer. A complete process has many smaller processes under it such as ordering, assembly, inspection, packing, and shipping. Cycle time is the cumulative time of the processes in the production operation.

Reducing cycle time focuses on implementing effective methods to shorten the time. Reducing cycle time requires the elimination of any activity or work that does not bring any benefits or does not play a significant role in the final product. Examples of such activities include damage repair time, machine maintenance, prolonged inspection, testing, and schedule overlap.

One study was conducted to determine the reduction of cycle time in the production process *mold*. While the production process has many interesting features, there is one obstacle to its growth in the industry. The downside is that the cycle time is too long for the production process. The cycle time for these problems includes the time taken for heating and cooling processes. The study was conducted by several researchers, including MZ Abdullah, S. Bickerton, Crowford, and Bhattacharyya.

Abdullah has experimented with reducing the cycle time of the casting process by adding nail polish (28% reduction) or roughness elements (18% reduction) to the outer surface of a mold. Other experiments that have been carried out include internal pressure, internal cooling, and water spray cooling.

Significant reductions in overall cycle time have been observed. Although the dominant factor in these comparisons is to leave an impression, it is difficult to quantify because these comparisons involve interactions between the two techniques (surface-enhanced molding and inner impact pressure). However, this combination should be considered by the industry as it offers a significant reduction in cycle time and significant improvements in the mechanical properties of the final product.

Based on the statement from Philips Thomas and the study from MZ Abdullah, it is well known that the importance of reducing cycle time can guarantee success in industry and manufacturing. Most customers urge manufacturers to move faster and at the same time the quality of the product should be improved to meet their needs. Through this study, the company should focus on ways that it can reduce the cycle time.

Reducing cycle time is a good starting point for improving production operations as it does not require significant capital investment. On the other hand, the length of the cycle will result in the high of stock quantity, requiring high maintenance costs but less customer satisfaction.

Customers generally evaluate a supplier's performance on four factors: product performance (features), price, quality, and

delivery within a reasonable time frame. Overall, reducing cycle time has several distinct advantages such as:

- i- Customer demand for products to be completed in a short time.
- ii- Increase productivity.
- iii- Reduce manufacturing process.
- iv- Reduce production costs.

3.5 Management and Reducing Cycle Time

In the 1950s two prominent Americans, Edwards Deming and Joseph Juran, introduced the techniques of advanced quality control for the Japanese while Japan rebuilt its empire. Over the next 20 years, the Japanese community can improve its quality by practicing management and reducing cycle time. In the 1970s, the quality of Japan's products was at its highest, and Japan easily acquired important stocks in the western market.

Managing and reducing cycle time can reduce the amount of time required for all activities involved including ordering, design, supply management, production, and more. Managing and reducing cycle time has two goals to achieve:

- i. Improve the cost and quality of the product. The reduction of cycle time is very suitable to be studied for activities in progress. This is because it allows non-essential activities to be removed from the production process. With this, the product development process becomes shorter. The quality of the product can also be improved because the existing time is focused to be used to the essential processes only.
- ii. Finding real-time for each activity. Reducing cycle time helps management find the exact time each process requires. Once a

deduction for unnecessary activity is performed, the time allocated for that activity can be determined.

The study of cycle time at the studied industry will focus more on the problems that directly and indirectly impact the cycle time of each production process. Subsequently, solutions to these problems will be proposed to reduce cycle time.

3.6 Quick Response

Michael Donovan states, "Many companies have problems delivering products at the right time, and most companies take too long to do so. This is because there is a lot of waiting time in the production process."

The waiting times are waiting for processing instructions, waiting for raw materials, waiting for process maintenance, and more. This waiting period will increase inventory, increase costs, and cause customers to lose confidence in the company.

The adverse effects of long wait times are very broad and can affect the productivity of a company. The wait-time problems in the production process are as follows:

- 1) Poor delivery system. Due to the poor delivery system, it makes customers unhappy with the way they manage their company. Delivery on time and customer satisfaction should be taken into consideration. Too long a cycle can cause customers to lose trust and companies are more likely to suffer losses if customers withdraw and choose to deal with other companies.
- 2) Business is too complicated. In doing business, the process of handling sales, receipt of materials, production schedule,

and any other activities should not be handled in such a complicated way as it will only prolong the cycle. Management should be carried out in an orderly way to reduce the cycle time and processing costs of a product.

- 3) Bottlenecks. Bottlenecks occur when there are some problems with the production process. For example in the workflow, each process is related to each other. If there is a problem with one process, it will disrupt the next process. This will cause bottlenecks and cause the workflow to go down smoothly. The problem of bottlenecks will result in wasted time and indirectly, the cycle time taken by the process is longer.
- 4) Too much extra activity. Examples of additional activities include the relocation of raw materials and renovations to production areas. This activity will only prolong the cycle and delay the production process and the longer the wait time. When the activity of producing a product takes too long, this means that the product delivery to the customer must also be postponed.
- 5) Low-quality level. When the quality of the product produced does not satisfy the customer, so the product will be returned to the factory. The company has to review the product to satisfy the customer. These events can be avoided if each product is given enough attention before it is sent to the customer. When this happens, more time and costs are required to conduct a second check. Good quality should be maintained to give customers the confidence to continue to do business with the company.

3.7 Layout Facilities

Machine layouts, storage areas of the work area, and office usually have limited space according to the firm's space capacity (Henry 2003). A plan is intended for determining and organizing requirements such as machines and other equipment within a space. It allows for a smooth flow from the raw material input, the production process, to the final process with low cost and limited oversight and control. (Richard Multer.1973)

3.8 Layout Problems

Problems with layout have been identified for the past few decades (Meller and Gau, 1996). However, most research approaches to layout in the manufacturing system are incomplete and are not well used in solving layout problems effectively. Effective layouts play a very important role in the manufacturing process (Canen and Williamson, 1996). The layout is designed based on the importance and achievements that the industry wants to achieve (Allegrì 1984, Tompkins et al.2003). Many technologies such as algorithms, computer simulation (Azadivar and Wang, 2000), fuzzy logic theory (Cheng and Gen, 1996), dynamic programming (Rosenblatt, 1986) have been developed. The purpose of all these technologies is to help their companies find more effective procedures.

Algorithmic approaches are commonly used to simplify design problems as well as to achieve goals and serve as a practical solution (Peters and Yang 1997; Cardarelli and Pelagagge 1995, Geiger 1997). This approach usually involves only quantitative

input data. While the output of the algorithmic approach is often needed to make future improvements according to design requirements such as the shape of each part, supply facility, material maintenance system, ergonomics, storage works, demand space, etc. (Yang, Taho Su, Chao-Ton, Hsu, Yuan-Ru, 2000).

In a procedural approach, Muther (1973) introduced a systematic layout planning (SLP) method which not only used to create new layouts for tools but also became a guide for the design and widely used by all organizations (Yang 2000). SLP is known around the world as a way to build layouts. Thousands of projects are all successful using the SLP approach. This study uses Muther's approach in systematic layout planning to solve layout problems in hard disk production. ARENA software will be used to evaluate design alternatives. There are three sections in this study that involve SLP. The first is to describe the work for SLP, the second is to describe the actual situation in the plant using the SLP workflow and ARENA software, and the third is the preparation of conclusions and discussion of future research needs.

3.9 Factors Affecting Layout

According to Henry (2003), the factors that influence layout design are as follows:

- i. Volume and weight of goods to be produced.
- ii. Properties of services provided.
- iii. Cost of area or building for product development.
- iv. The facilities provided for the product.
- v. Product or component weaknesses.

3.10 Advantages of Good Layouts

Henry (2003) presented his study result and concluded that good layouts bring many advantages to companies to enhance production activities such as:

- i. Reducing *bottlenecks* in the movement of employees or products.
- ii. Reduce material handling costs.
- iii. Reduces harm to individuals.
- iv. Employee utilization is more effective.
- v. Create a working spirit.
- vi. Effective use of space.
- vii. More flexible.
- viii. Facilitate supervision.

3.11 Types of Layouts

Evans (1997) in his book '*Production & Operation Management: Quality, Performance, and Value*' states the layout plan is divided into four categories:

- i. Layout process.
- ii. Product.
- iii. Cellular (Group Technology).
- iv. Layout fixed-position.

2.11.1 Process layout

Process layouts are the standard layout used in the production process to streamline workflows. Figure 2.3 shows an example of a process layout.

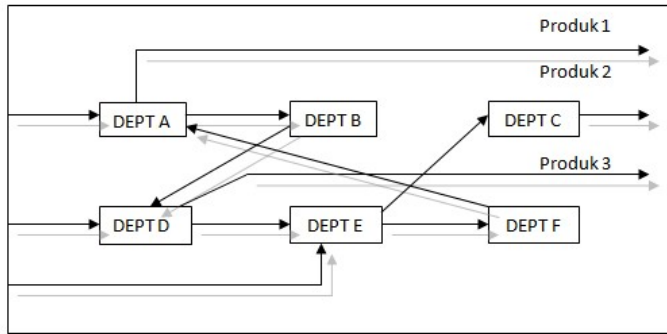

Figure 2.3. Process layout (Source: James R.Evans.1997)

2.11.2 Product layout

These layouts are used to handle multiple processes and link to each other.

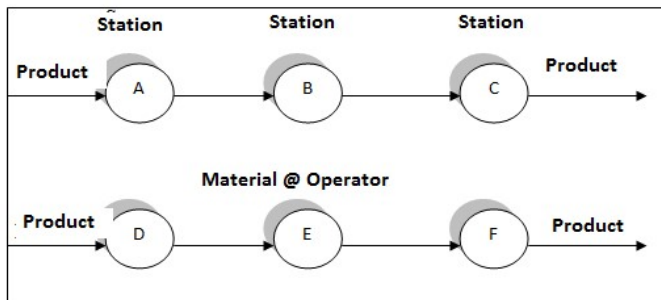

Figure 2.4. Product layout (Source: James R.Evans, 1997)

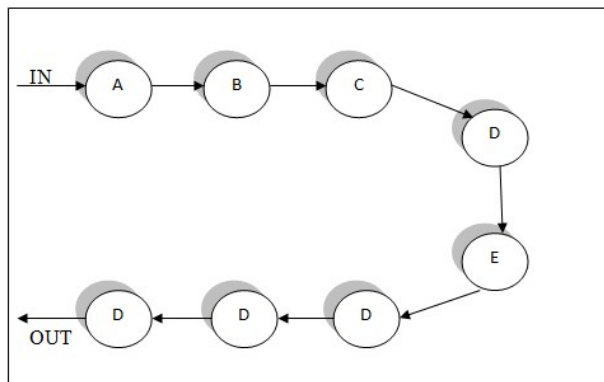

Figure 2.5. Product layout/U-Shape (Source: JR. Evans, 1997)

3.12 Systematic Layout Planning (SLP)

SLP is a technique developed by Richard Muther *et al.* There are three basic areas involved in this technique: Connection, Space, and Control. This technique enables users to identify, observe, and evaluate the various types of activities, relationships, and solutions involved in project layouts (Muther 1973).

There are fourteen objectives in the design layouts using SLP approach, namely:

- Provide sufficient space in the production of material
- Reduces maintenance costs
- Reduces movement of workers and also to reduce the danger to the workers
- The effective use of workers
- Boost employee morale
- Use more effective space
- Reducing accidents
- Facilitating maintenance work
- Simplifying coordination and communication
- Prioritizing worker safety and health
- Increasing machine
- Productivity

According to Evans (1997), there are several advantages and disadvantages of using SLP as one of the methods to solve the layout problem. Among the advantages are:

- It is a clear and logical technique for layout.
- It can determine the importance of the relationship between one side and the other.
- Controlled through the concept of *trial and error*

- The process will be more flexible

Among the disadvantages are it requires many individuals skilled in handling, and also it is difficult for production planning and control.

According to Richard Muther (1973), Systematic Layout Planning (SLP) involves eleven sequences starting with step 1(input data and activities), step 2(flow of materials), step 3 (activity relationships), step 4 (relationship diagram), step 5 (space requirements), step 6 (space available), step 7 (space relationship diagram), step 8 (modifying considerations), step 9(practical limitations), step 10 (develop layout alternatives), and step 11 (evaluation).

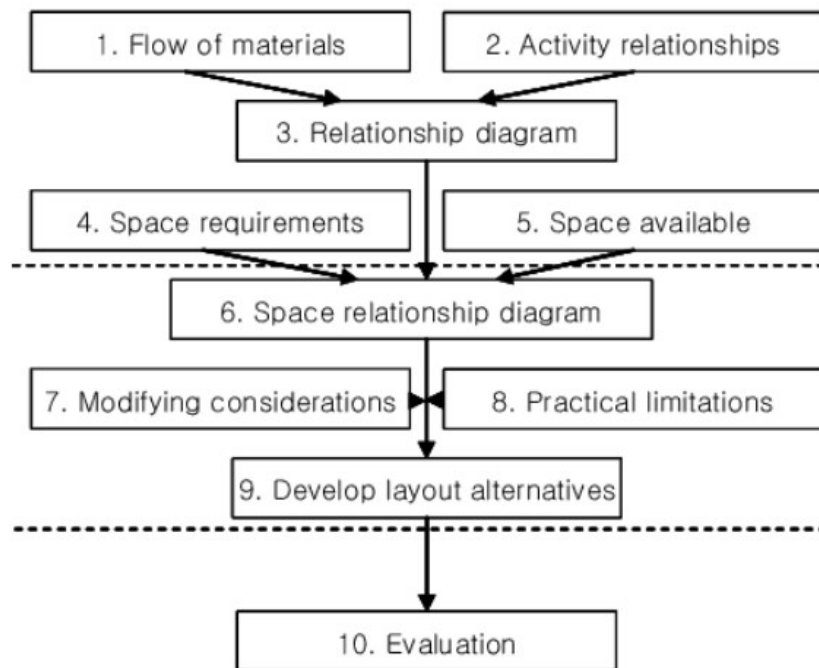

Figure 2.6.Eleven steps Muther’s Systematic Layout Planning

3.13 ARENA Software

According to Uttapol Smutkupt (2009), ARENA software is a combination of high-level software used to simulate and analyze the effects of changes that involves to redesign related to supply chain, manufacturing, process, logistic, distribution, and warehousing, as well as service systems. ARENA software is flexible and widely used in applications that include very detailed and complex models (ARENA Simulation, 2009).

Some of the scenarios involved in the use of Arena software include:

- Detailed analysis of all types of production systems including material and component management.
- Analyze customer service and customer management systems.
- Comprehensively analyze the supply chain including warehousing, transportation, and logistic systems.
- Predict system performance based on metrics such as cost, cycle time, and usability.
- Identify the causes of bottlenecks such as delays at a station as well as the excessive use of available resources.
- Designing workers, tools, or essential goods.

3.14 Conclusion

This chapter discusses literature relating to this study such as discussion about cycle time, time category definition, motion study, cycle time reduction, time management, layout facilities, layout issues, layout advantages, and disadvantages and use of

Arena software. The next chapter discusses the methods or techniques that will be used to make this study successful conducted.

CHAPTER III

METHODS OF STUDY

3.1 Introduction

In this chapter, several methods will be discussed to conduct cycle time study in the studied company. These methods will be used to collect and analyze data related to the company production time. The layout study is one of the problems that may affect the production cycle time. Solutions to the layout will reduce cycle time and increase efficiency and productivity at this company. It is important to understand the workflow and processes involved in the company. All of these methods play an important role in the success of this study.

3.2 Research Methods

It is important to use any certain methods to collect and then analyze the collected data. There are two methods used in this study which are observation methods, and SLP approach followed by the application of ARENA software.

The use of stopwatch is a direct observation method. The use of a stopwatch is the most suitable method to obtain time readings. Each work process will be recorded using the stopwatch, and the time value can then be rewritten in the work schedule more easily. The use of the stopwatch in this study used two different types of clock, namely continuous stopwatch and snapback stopwatch. Some of the key steps in this method are:

- i- Identifying each process to be studied.
- ii- Determines how often the readings are taken as well as the quantity of samples to be studied.
- iii- Take readings using a stopwatch and record the data in the form.
- iv- Calculating the average real-time. The actual average cycle time is the total amount of time per read per sample.

The second method is an approach named as systematic layout planning (SLP) functioning to create new layouts in production. The proposal to create a new layout is to improve the original layout problems in the company, because the layout will affect the cycle time in production hard disk. Two alternative layouts will be featured in this study. On the other hand, the use of Arena software is to simulate the new layouts resulted from the using of SLP method.

3.3 Workflow

In the workflow to complete this study, the implementation phase is divided into two phases namely the implementation of the first phase and the implementation of the second phase. The first phase involves a literature review, identifying the plant according to the relevance of the study, making a rough assessment of the entire plant to be studied, gathering information and data, and identifying the problems faced by the plant that affect the cycle time of each process.

While the implementation of the second phase of work involves the extension of the first phase of analyzing problems and identifying the causes of problems, generating solutions and recommending them to the plant and preparing final reports for this study. The flowchart below shows the workflow or steps that will be conducted to be as a guide in this study.

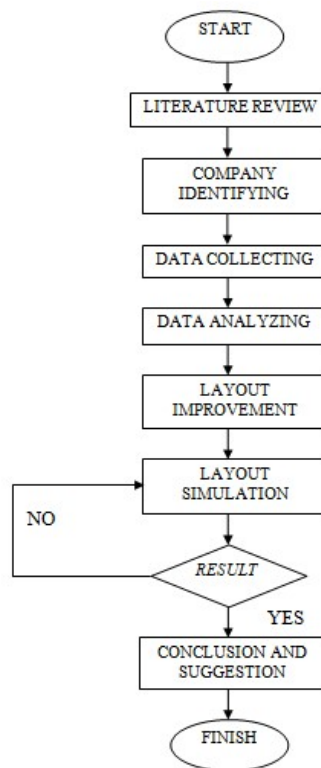

Figure 3.1. Flowchart methodology

3.3.1 Literature review

Literature Review is a composed of journal, website, and also books used in this study. The literature review covers the background of topics, theories, issues and even the history of past studies related to cycle time. Library studies are not only focused on the cycle, but they are also related to the layout of an organization and its impact on the company's production level.

3.3.2 Identifying the factory

It is important to identify the appropriate plant and to comply with the topic of study to be undertaken. This is because, after several factories visited, the studied industry plant complies with the scope of the study as well as the state of the plant in terms of the process of producing its products to facilitate the study. Through this observation, many of the reforms are possible in the studied industry but are still limited by the consent of its management.

3.3.3 Data collection

The next step is to collect data relating to cycle time. The method of collecting data is to use a stopwatch to record the time of each related process and record it in a table format.

3.3.4 Analyzing data

In this study, the SLP system is used as a research method to analyze the layout problems in production *hard disk*. The following steps are required in the SLP application to find

information before simulating the SLP result by using ARENA software.

3.3.4.1 Build relationship chart

In a first step, it is important to find a correlation between activity, area, function or design of the buildings involved in the layout based on the requirements of the position (A, E, I, O, U, X).

- Identify each activity and list all activities in the contact chart.
- Determine the relationship or level of need of each activity to other activities. (A- Very useful, E- Very important, I- Important, O- Normal, U- Not important, X- Not relevant).
- In using a graph, it is necessary to follow the grid flow. For example, if a comparison is made between the first activity and the third activity, then the correlation between the first and third activities should be made so that it is shaped like a diamond which is the intersection between the two activities.
- Diamond cells are separated by a line. Use a diamond cell separator to record the connections at the appropriate level. The choice of connectivity can be determined by the user himself such as security, material flow and even the use of tools.

3.3.4.2 Building the Required Space

In this second step, the space, requirements and obstacles or distances required will be recorded for each activity. What to do is:

- Name the type of activity involved
- Identify the space required for each activity

- Identify the boundaries by importance (A, E, I, O, U, X)

3.3.4.3 Building a Relationship Diagram

Third level is to find the relationship between the needs of each activity. The AEIOUX correlation scale is as follows:

$$Scale = \frac{maximum - minimum}{6}$$

$$= \frac{238-0}{6} = 40$$

A	201- above	Essential	▬▬▬▬▬▬
E	161 – 200	Very Important	▬▬▬▬▬▬
I	121 – 160	Important	▬▬▬▬▬▬
O	81 – 120	Ordinary	▬▬▬▬▬▬
U	41 – 80	Non-Ordinary	▬▬▬▬▬▬
X	0 – 40	Irrelevant	

Figure 3.2. Diagram of the relationship between activities

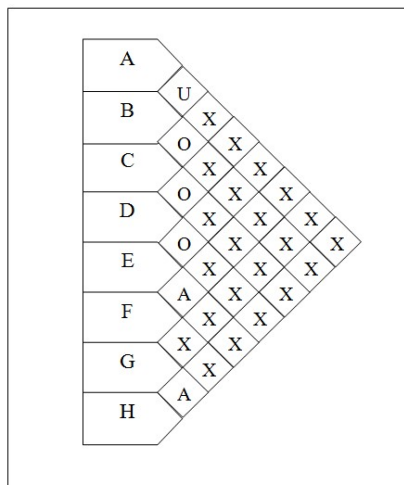

Figure 3.3. REL chart

3.4 Layout Interpretation Using ARENA

The Arena Software is an invention used to analyze the changes effects between supply chain, manufacturing systems, processes, logistics, distribution and storage and service systems.

3.4.1 Startup layout

Starting Arena by clicking *Windows start* menu, and then go to Program > Rockwell > Software > Arena. The Arena model will be displayed with the new model as shown below.

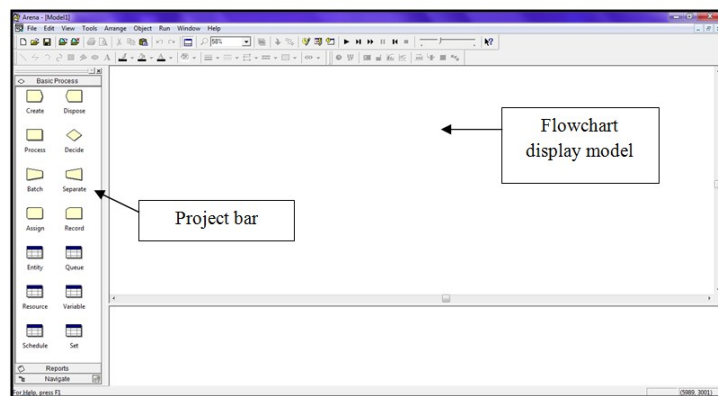

Figure 3.4. Arena view

To model the Arena, there are three parts to the application window:

- a) Process Basics: contains various forms of process to be modeled, called modules.
- b) Report Panel: contains appropriate reports to be displayed after the simulation is run.

- c) Navigate Panel: allows the user to display model views, including model directions through sub model hierarchy and to allow models to be displayed in thumbnail.

3.4.2 Model description

The idea to develop a model is a very simple effort and no need to many efforts to develop it. This development begins by identifying the basic functions of each process in the *project bar* such as icon to *create, process, decide and dispose*. Then all of these functions will be built into a single process stream representing real processes in the industry. Unfortunately, this Arena software does not provide the accuracy of solving a product in the form of U. Besides, the model can be played in animated form to make it more attractive. The model will then be simulated to check the function, suitability and validity of the model rules. In the final stage, the selection of the process is possible based on the best possible layout solution. Table 3.1 shows a description of each process flow involved in developing the model for this study.

Table 3.1. Process flowchart

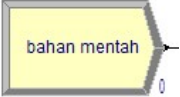
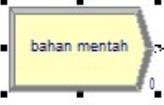
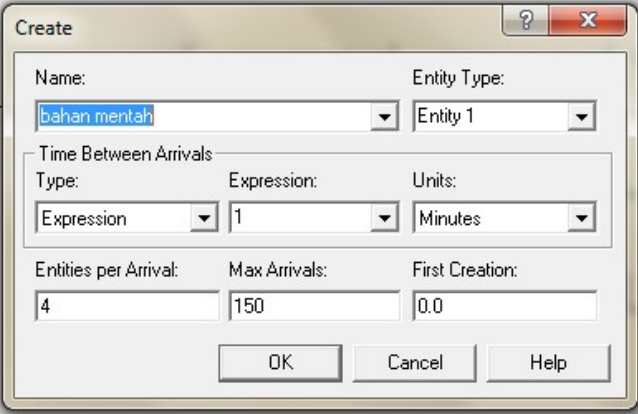
block	description
	<div style="display: flex; align-items: center;">  <div style="margin-left: 20px;">  </div> </div> <ul style="list-style-type: none"> ● Item create is used only to represent the startup process in a system. In this study, the first process in the production of hard disk is raw material input

The image shows a simulation software interface. On the left, there is a yellow rectangular process block labeled 'stamping' with a small '0' below it. To its right is another identical 'stamping' block with a small '0' below it. A 'Process' dialog box is open over the second block. The dialog box has the following fields and options:

- Name: stamping
- Type: Standard
- Logic: Action: Seize Delay Release; Priority: High(1)
- Resources: Resource_Resource 1, 1; <End of list>
- Delay Type: Expression; Units: Minutes; Allocation: Non-Value Added
- Expression: 0.1
- Allocation dropdown menu: Value Added, Non-Value Added (selected), Transfer, Wait, Other
- Report Statistics

- The stamping process refers to the action of the source of supply such as seize, delay, release, quantity of input and also the processing time displayed in the expression section.

The image shows a simulation software interface with a 'piling' process box and its configuration dialog. The process box is a yellow rectangle labeled 'piling' with a '0' below it. The dialog box, titled 'Process', has the following settings:

- Name: piling
- Type: Standard
- Logic: Action: Seize Delay Release; Priority: High(1)
- Resources: Resource, Resource 2, 1; <End of list>
- Delay Type: Expression; Units: Minutes; Allocation: Non-Value Added
- Expression: 0.5
- Report Statistics:

- The piling process is a process whereby hard disks that have gone through the stamping process are arranged in layers according to the specified quantity.

The image shows a simulation software interface. On the left, there is a yellow rectangular resource labeled 'platen' with a small '0' below it. To its right, a similar 'platen' resource is shown with a blue selection box and a small '0' below it. On the right side, a 'Process' dialog box is open. The dialog box has the following fields and options:

- Name: platen
- Type: Standard
- Logic: Action: Seize Delay Release; Priority: High(1)
- Resources: Resource Resource 3.1 (selected), <End of list>
- Delay Type: Expression; Units: Minutes; Allocation: Non-Value Added (selected)
- Expression: 0.4
- Allocation dropdown menu: Value Added, Non-Value Added (selected), Transfer, Wait, Other
- Report Statistics
- Buttons: OK, Cancel, Help

- At this stage, the hard disks arranged at the piling stage will form a platen, where the volume of the hard disk at this level is 12,000 pieces. Later, the platen will be left waiting for the next process. Therefore, the action for this

process is also to refer to the seize delay release.

The image shows a process flow diagram on the left and a 'Process' dialog box on the right. The diagram consists of two yellow rectangular boxes labeled 'annealing'. The first box has a small '0' below it. The second box is connected to the first by a horizontal line with a double-headed arrow, and a vertical line with a double-headed arrow, indicating a relationship between the two processes. The 'Process' dialog box is titled 'Process' and contains the following fields:

- Name: annealing
- Type: Standard
- Logic: Action: Seize Delay Release; Priority: High(1)
- Resources: Resource, Resource 4, 1; <End of list>
- Delay Type: Expression; Units: Minutes; Allocation: Non-Value Added
- Expression: 18
- Allocation dropdown menu: Value Added, Non-Value Added (selected), Transfer, Wait, Other
- Report Statistics:

- Annealing is a heating process hard drive a 7-hour aimed at improving the mechanical properties of hard disks.

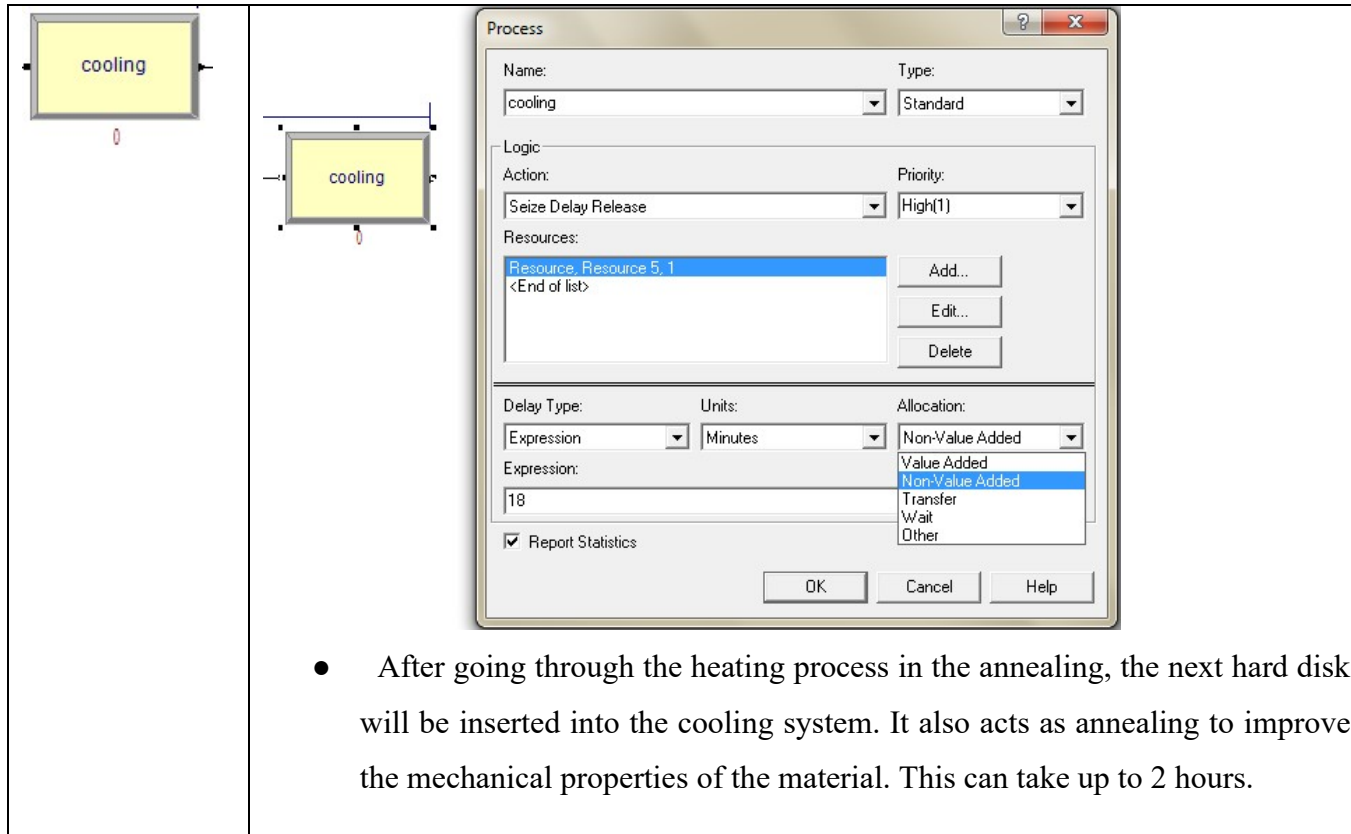

The image shows a simulation software interface. On the left, there is a yellow rectangular process block labeled 'cooling' with a small red '0' below it. To its right is a smaller version of the same 'cooling' block with a red '0' below it. On the right side of the interface is a 'Process' configuration dialog box. The dialog box has the following fields and options:

- Name: cooling
- Type: Standard
- Logic: Action: Seize Delay Release; Priority: High(1)
- Resources: Resource: Resource 5, 1; <End of list>
- Delay Type: Expression; Units: Minutes; Allocation: Non-Value Added
- Expression: 18
- Allocation dropdown menu: Value Added, Non-Value Added (selected), Transfer, Wait, Other
- Report Statistics:

- After going through the heating process in the annealing, the next hard disk will be inserted into the cooling system. It also acts as annealing to improve the mechanical properties of the material. This can take up to 2 hours.

The image shows a simulation software interface. On the left, a yellow rectangular process box labeled 'deblock' is shown with a small red '0' below it. To its right, a larger version of the 'deblock' process box is shown with a red '0' below it, and a configuration dialog box is open over it. The dialog box is titled 'Process' and contains the following fields:

- Name: deblock
- Type: Standard
- Logic:
 - Action: Seize Delay Release
 - Priority: High(1)
- Resources:
 - Resource, Resource 6, 1
 - <End of list>
- Delay Type: Expression
- Units: Minutes
- Allocation: Non-Value Added
- Expression: 2.1
- Allocation dropdown menu options: Value Added, Non-Value Added, Transfer, Wait, Other
- Report Statistics

Buttons at the bottom of the dialog are OK, Cancel, and Help.

- De'block is a process that needs to be performed by the operator where the hard disk in the form of a platen will be distributed to the operator for inspection.

The image shows a simulation environment with a 'flatness' process box on the left and its configuration dialog on the right. The dialog is titled 'Process' and contains the following settings:

- Name: flatness
- Type: Standard
- Logic:
 - Action: Seize Delay Release
 - Priority: High(1)
- Resources:
 - Resource_Resource 7_1
 - <End of list>
- Delay Type: Expression
- Units: Minutes
- Allocation: Non-Value Added
- Expression: 0.2
- Report Statistics

Buttons at the bottom of the dialog are OK, Cancel, and Help.

- The flatness process is the micron flow inspection process found on each hard disk. At this stage, any identified defects will be excluded as reject.

The image shows a simulation software interface with a process named "unstick" and its configuration dialog box. The dialog box is titled "Process" and contains the following fields:



- Name: unstick
- Type: Standard
- Logic: Action: Seize Delay Release; Priority: High(1)
- Resources: Resource, Resource 8, 1; <End of list>
- Delay Type: Expression; Units: Minutes; Allocation: Non-Value Added
- Expression: 0.4
- Allocation dropdown menu: Value Added, Non-Value Added (selected), Transfer, Wait, Other
- Report Statistics:

Below the dialog box, there is a bullet point:

- Hard disk that has gone through processes annealing and cooling will be attached. In the process *unstick*, each piece of hard disk will be loosened and stacked in a stackbar of 100 pieces on each stack bar.

The image displays a 'Decide' icon in a process flow, a smaller 'Decide 1' icon with 'True' and 'False' paths, and a 'Decide' dialog box. The dialog box shows 'Name: Decide 1', 'Type: 2-way by Chance', and 'Percent True (0-100): 90 %'. Below the dialog box is a bulleted list explaining the icon's use.

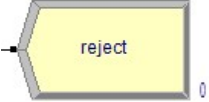
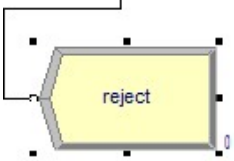
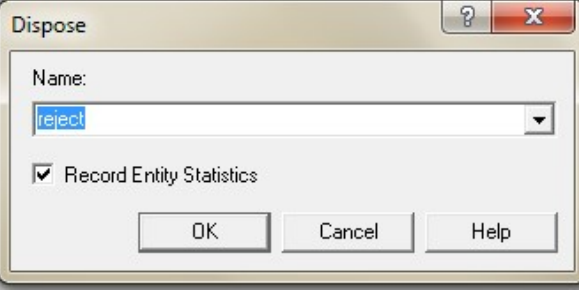
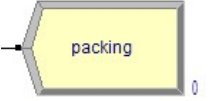
- The decide icon is used when there are options in the process. In this study, a good hard disk with no further defects will go through the packing process. While hard disks are defective they will be rejected. Determination of permissions in this operation is set to 90%.

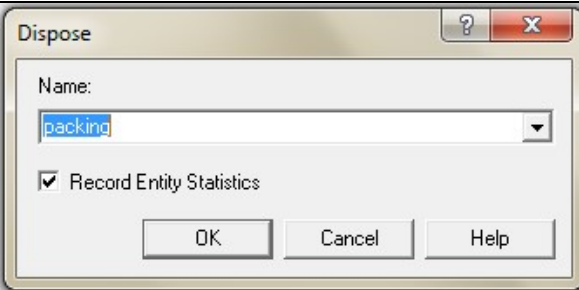
- Packing is the final process in the blanking section where all selected hard disks will be transported to another area for the shipping process.

3.5 Conclusion

This chapter discusses the methods used to conduct the objective of study as informed on Chapter 1. This step is important in this cycle time study in relation to determine the data of proposed layout from each developed layout. By using the collected data, analyzing process by using Arena software will be continually conducted to evaluate each developed layout. The use of Arena software allows evaluation of the original layout, layout alternatives and the other simulation outputs.

CHAPTER IV

RESULTS AND DISCUSSION

4.1 Introduction

In this chapter, all the gathered data will be analyzed in detail. Each analysis plays an important role in ensuring that the objectives of this study are achieved successfully. To obtain time for each process, a manual method was performed using the stopwatch and the time would be recorded in the table provided. For factory layout analysis, the use of Arena software will suggest a good layout option in terms of both process cycle time and production throughput.

4.2 Observation Results

Based on observations on the studied company, it appears that production operators are working in a less systematic machine layout. Initially, the owner of the company did not consider any systematic method for machine layout in production. The effects of an unsystematic layout can actually be a huge loss to a company because there is a waste of time it takes to produce a product. Saving time will bring double benefits to the company as more output can be produced in less time. In addition, it can be noted that there are some disadvantages to the ineffectively factory layout because of a severe work environment, cross line, time wasting, and bottle neck which all of these will affect the company's output. In addition, the operator also has to take more time to ship the hard disk pieces from one part to the other. The obvious problem is in the packaging area where the

bottleneck happened during waiting the operator bring finished products to the packaging area.

4.2.1. Process flow

In this study, the first step is to identify each involved process in production *hard disk* computer. Each process flow needs to be understood to facilitate the classification of the types of time involved in a process such as waiting time, processing time, check-in time and even time. Table 4.1 below describes each process involved in this study which is limited to the production area only.

Table 4.1. Process description

	Area name	Description
A	Raw Material	This area contains raw material sent by the supplier before the next process. These raw materials are of aluminum type material that comes in a circular shape or coil of varying thickness.
B	<i>Stamping @ punching</i>	This area is the first process that raw materials will go through. This stamping process will coil the shape of a specific diameter circle according to the type of hard disk.
C	<i>Piling</i>	Also known as the load-adding process which the second process that the through hard disk goes.

		Each piece of hard disk that is produced will be arranged in a certain quantity and will be fitted with a number of loads intended as a fastener between the hard disk and the pressure gauge.
D	<i>Platen</i>	Hard disk that has been fitted with a load enhancer is known as platen. The platen is then placed in a waiting area before it is inserted into the chamber annealing.
E	<i>Annealing & Cooling The system</i>	Annealing and cooling are a process of heating and cooling that will be experienced by hard disks which are intended to enhance the mechanical properties of materials such as durability, hardness and so on.
F	<i>De'block</i>	The De'block area is an inspection area that serves as the supply area of hard disk before it is transferred to the next process of flatness and unstick.
G	<i>Flatness & Unstick</i>	The use of conveyors to combine these two processes is through the use of manpower. The hard disks

		<p>that come out of the process annealing and cooling will stick to each other. The flatness process is the process of checking the pieces hard disk under the surface of the (spacer) and the loader unstick is the process of separating the hard disk into piece by piece. During the inspection of the hard disk , the operator will identify the physical quality of hard disk on its surface. For this problem, the non-reusable hard disk will be isolated for the re-process.</p>
H	<i>Packing</i>	<p>This area houses all of the hard disks that are ready to be inspected before being transported to another area for further processing.</p>

4.2.2. Process time

Each process has different timings depending on the way it operates and the distance the area connects it from one section to another. Cycle time calculation includes waiting time, processing time, check-in time and maintenance time. Table 4.2 shows the time taken for each involved process to produce *hard disk*. The time was

recorded using the stopwatch and the values below were averaged for each of the three readings.

Table 4.2: Time for each process

Process	Time wait	time processing	time maintained	Time check
Stamping	1.0 s	3.3 hours	-	-
Piling	4.0 min	30 min	-	-
Platen	3 hours	-	5 min	-
Annealing	-	2.3 hours	8 min	-
Cooling	-	0.67 hours	8 min	-
De'block	-	15 min	-	-
Flatness	2.4 s	1.8 s	3.5 s	3.0 s
Un-stick	1.8 s	2.0 s	2.5 s	2.6 s
packing	2.3 s	2.0 s	1.5 s	-

In performing analysis using Arena software, there is an space *expression* in the unit time will represent the proximity of one area to another. In this study, the value difference in the space *expression* will be entered into the Arena software based on the layout that was performed. Table 4.3 below shows the expression differences between the original layout and the new layout.

Table 4.3. *Expression* per layout

Process	Time		
	Expression Original (min)	Expression Alternative1 (min)	Alternative Expression 2 (min)
Stamping	0.1	0.1	0.1
Piling	0.5	0.3	0.2

Platen	0.4	0.3	0.2
Annealing	18.0	13.0	9.0
Cooling	18.0	13.0	10
De'block	2.1	2.0	1.3
flatness	0.4	0.2	0.2
Un-stick	0.4	0.3	0.2

4.3 Systematic Layout Planning

Involved area to produce hard disk in this study is in the *blanking* area. The hard disk production in this area is slow because the existing layout is less systematic. Plans have been made to enhance and expand production capacity through the creation of new designs. Arena software is used to prove that the amount of output in a new layout can produce is higher than that the existing layout do. The proposal to create a new layout is to solve the original layout problem in the studied company. The alternative layout features proposed in this production section are based on:

- a) Maintaining the number of machines and equipment available
- b) The maximum distance for the renovation is 5 meters.
- c) The area of production area is the same as 27.5m x 86.8m.

At each stage of the original activities, areas, functions and positions of the plant are directly involved in the construction of rating charts based on ratings (A, E, I, O, U, X). The average output in the blanking section is between 500 pieces and 600 pieces of hard disk per operator for each shift. Expected output after layout improvement is 900 pieces of *hard disk* and above. In maintaining the number of machines and equipment available in the factory, the

layout concept of Evans, 1997 was used in the planning of the new layout.

i- Identify each activity and list it on the contact chart.

a. Material flow analysis.

This stage is a synthesis of all the different process streams of functions and regions into new ones (Taho Yang, 2000). The number of lot sizes per week from one section to another will be included in Table 4.4. The table shows the number of lot sizes per week between a process and a related process.

Table 4.4. Number of lot size per week

From	To							
	A	B	C	D	E	F	G	H
A		21	0	0	0	0	0	0
B	0		38	0	0	0	0	0
C	0	0		38	0	0	0	0
D	0	0	0		14	0	0	0
E	0	0	0	0		14	0	0
F	0	0	0	0	0		14	0
G	0	0	0	0	0	0		14
H	0	0	0	0	0	0	0	

b. Correlation analysis activities.

The distance between each section was computed as shown in Table 4.5.

Table 4.5. The distance between each section

From	To							
	A	B	C	D	E	F	G	H
A		2	36	43	10	37	18	2
B			33	8	10	6	7	21
C				5	7	6	7	23
D					6	5	5	30
E						17	17	30
F							2	24
G								29
H								

c. Total distance

Total distance is the sum of the frequency of activity or volume of size multiplied by distance for each section as shown in table 4.6.

Table 4.6. Total distance

From	To							
	A	B	C	D	E	F	G	H
A		42	0	0	0	0	0	0
B			114	0	0	0	0	0
C				190	0	0	0	0
D					84	0	0	0
E						238	0	0
F							28	0
G								40

H								
---	--	--	--	--	--	--	--	--



ii. Analyzes of relationship charts

The level of need for each activity to other activities (A-essential, E-very important, I-important, O-ordinary, U-non-essential, X-irrelevant) will be determined using the relationship chart.

$$Scale = \frac{maximum - minimum}{6}$$

$$= \frac{238-0}{6} = 40$$

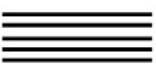
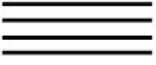
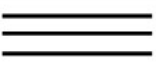
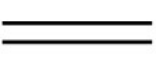
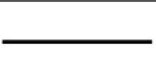
Table 4.7. Relationships between activities

A	201- above	Essential	
E	161 – 200	Very Important	
I	121 – 160	Important	
O	81 – 120	Ordinary	
U	41 – 80	Non-Ordinary	
X	0 – 40	Irrelevant	

iii. REL chart

Relationship chart shows the potential for good linkages between each region (Taho Yang, 2000). It facilitates potential needs at the pre-defined level and thus the choice of the interconnected space can be determined. This can be achieved by flow diagrams or relationship among one area function to

other area functions as shown in Figure 4.1. The use of graphs through triangular grids links the intersections of one activity to another and determines the level of activity of each. Figure 4.2 is a layout illustration using REL chart.

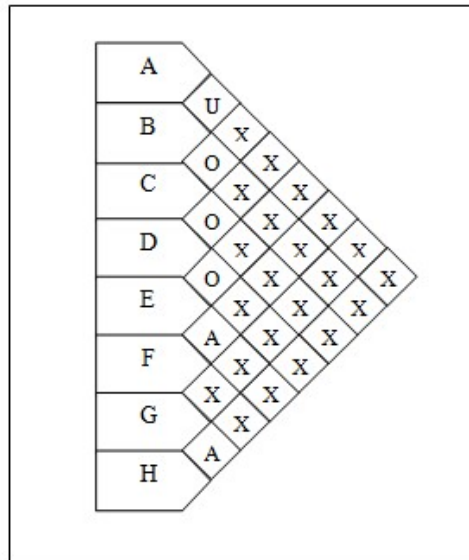

Figure 4.1. Relationship among area by using REL-chart

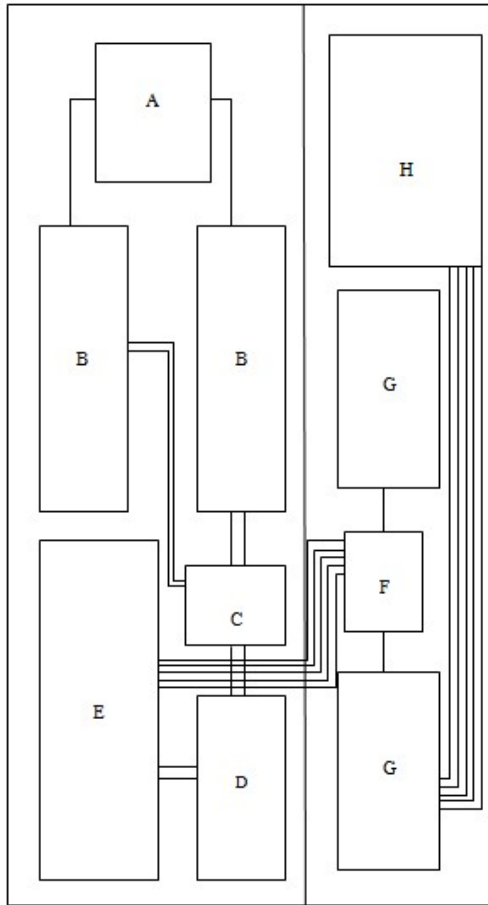



Figure 4.2. Layout overview using REL

4.4 Building Requirements.

At this stage each area, usage, and limitation needed for each activity will be considered. The requirements for the shape of each area are considered as rectangular shapes as shown in Table 4.8.

Table 4.8: Requirements existing space

Code	Area	Shape	Size		Area
			Length(m)	Width (m)	
A	Raw material		6	4.5	27
B	Stamping		4.5	23	10
C	Piling		4.5	6.3	28
D	Platen		8.6	5.4	46
E	Anealling & Cooling		2	37	74
F	De 'Block		2	3.8	7.6
G	Flatness & unstick		3.8	21	79.8
H	Packing		4.7	17	80
Total size			36.1	119.5	361.4

4.5 Selection Layout

Several new alternative layouts have been created without changing the actual size of the machine or equipment in the factory. The second alternative is chosen to propose a new layout based on the importance of one activity over another. Figure 4.3 shows the actual layout of the plant while Figures 4.4 and Figure 4.5 show the alternative layouts 1 and 2.

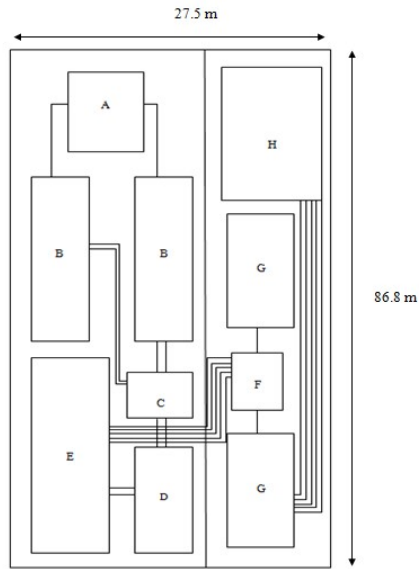

Figure 4.3. The actual layout of the factory.

Figure 4.4 shows the first redesigned layout sketch without resizing the original machine or tool. The change is made by moving the positions between C, D and E machines as shown above based on the chart and their respective requirements.

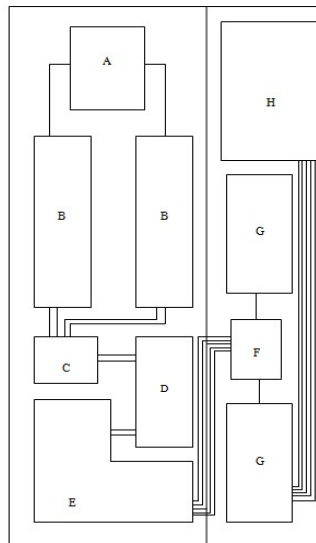

Figure 4.4. Alternative layout 1

Figure 4.5 shows the second alternative layout that has been made by changing the position of machine C, D and E. The second layout is an option in determining the best order of the study. This is because the position of machine E has been approached near the machine area F to shorten the movement of the operator from area E to F. The new arrangement further saves the movement time and thus shortens the overall cycle time in this blanking area.

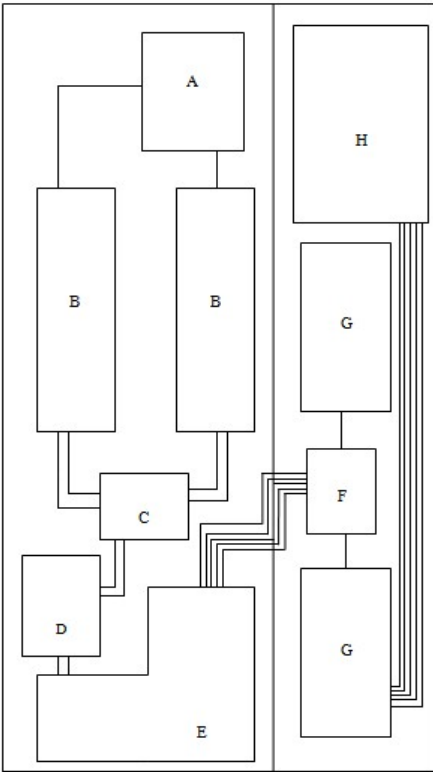

Figure 4.5. Alternative layout 2

Spacing changes play an important role in the value *expression* to be included in Arena software. Table 4.9 below shows the comparison of distances and *expressions* between the three layouts simulated using Arena software.

Table 4.9. The comparison of distance-expression among layouts

Code	Distance (m)	Expression original layout (min)	Alternative 1		Alternative 2	
			Dist. (m)	Expr. (min)	Dist. (m)	Expr. (min)
A - B	-	-	-	-	-	-
B - C	4	0.5	2.5	0.3	1.5	0.2
C - D	6	0.4	4.5	0.3	2.5	0.2
D - E	7	18.0	5	13.0	3.5	9.0
E - F	19	18.0	14	13.0	11	10
F - G	2	2.1	2	2.0	1.2	1.3
G - H	3	0.4	2	0.3	1.5	0.2

Distance determination made by:

$$expression = \frac{original\ expression\ (min)}{original\ distance\ (m)} \times new\ distance\ (m) \dots\dots\dots (4.1)$$

B - C

$$\frac{0.5\ min}{4\ meters} = 0.125\ min / meter$$

Thus, it can be seen that the movement of operators from area B to C is 0.125 min per meter. Therefore, for the determination of expression in an alternative layout for B - C (at a fixed distance of 2.5 meters) is

$$0.125 \times 2.5\ meters = 0.3\ min$$

A 0.3 minutes value will be entered into the Arena software in the value section *expression*.

4.6 Simulation and Evaluation Using ARENA

After selecting the desired layout, an evaluation using Arena software is performed to obtain data on the cycle times and outputs generated from the selected layouts. The entire process will be illustrated starting with modeling, simulation, visualization, and analysis. Figure 4.6 shows the hard disk production model according to the actual process flow. All evaluation data will be displayed at the end of the simulation.

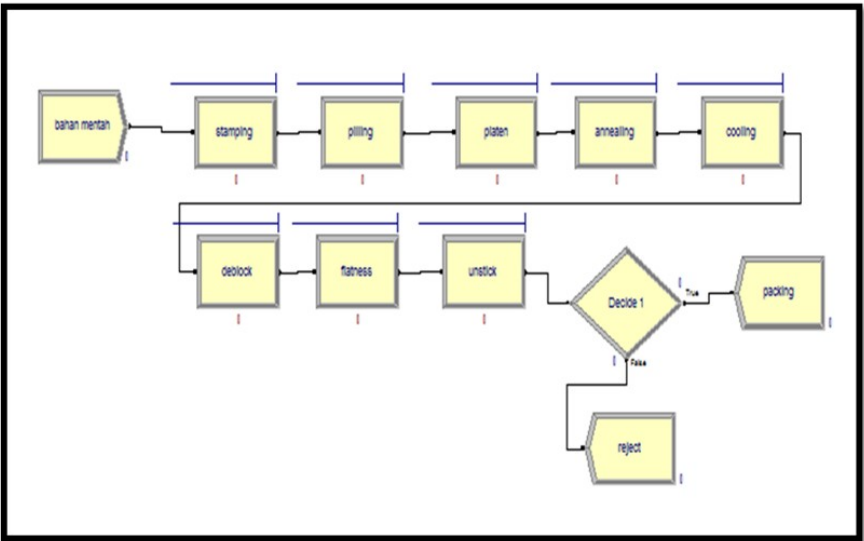

Figure 4.6. Computer hard disk production model

4.6.1 ARENA simulation

ARENA simulation can provide data for analysis, description, and evaluation of the study performed. It also connects the level of communication and information within the organization. Figure 4.7 shows a complete summary of the simulation process in the existing layout. The amount of time and output of each layout can be determined and analyzed to allow for a comparison of his or her other two alternative arrangements.

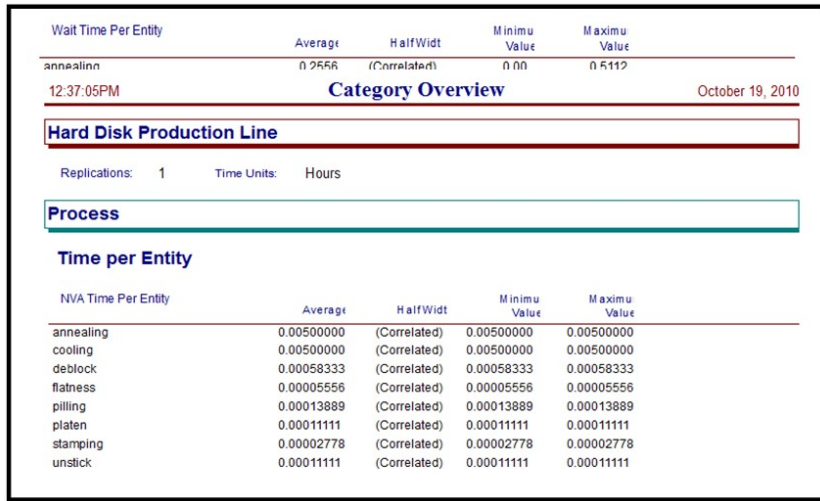

Figure 4.7. A complete summary of the original layout process

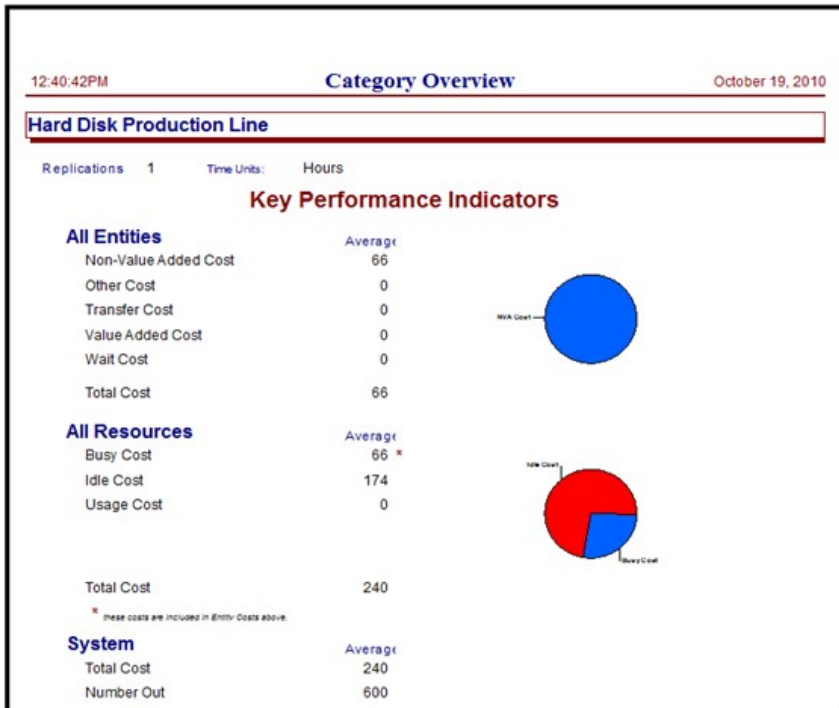

Figure 4.8. Performance indicators for the original layout

The performance indicators shown in the figures above are important to show the total output and production costs involved in a given layout. The total output on the original layout is 600 pieces of *hard disk* per person per shift.

Figure 4.9 shows the simulation results in which all data entered is verified by the SIM decision. Replication time for input is 3.006 hours of operation per-coil *hard disk*. The overall results of SIMAN are important to support the authors' research to validate data entered such as number of hours worked, hours of operation and cost of work.

```

Reading program file: C:\USERS\PUBLIC\DOCUMENTS\CURRENT_LAYOUT_1.P
Beginning replication 1 of 1

D.O Hours>
D.O Hours>

ARENA Simulation Results
acer - License: STUDENT

Summary for Replication 1 of 1

Project: Hard Disk Production Line
Analyst: Naamah Abdul Razak
Run execution date: 10/19/2010
Model revision date: 10/19/2010

Replication ended at time : 3.0060278 Hours
Base Time Units: Hours
  
```

TALLY VARIABLES					
Identifier	Average	Half Width	Minimum	Maximum	Observations
cooling.waitCostPerEntity	.00000	.00000	.00000	.00000	600
grilling.waitCostPerEntity	.00000	.00000	.00000	.00000	600
deblock.waitCostPerEntity	.00000	.00000	.00000	.00000	600
platen.waitTimePerEntity	.00000	.00000	.00000	.00000	600
stamping.waitCostPerEntity	.00000	.00000	.00000	.00000	600
flattness.waitCostPerEntity	.00000	.00000	.00000	.00000	600
annealing.TotalTimePerEntity	.24062	(Corr)	.00500	.51625	600
annealing.NVATimePerEntity	.00500	(Corr)	.00500	.00500	600
platen.TotalTimePerEntity	1.1111E-04	(Corr)	1.1111E-04	1.1111E-04	600
stamping.TotalCostPerEntity	2.7778E-04	(Corr)	2.7778E-04	2.7778E-04	600
platen.NVACostPerEntity	.00111	(Corr)	.00111	.00111	600
deblock.NVACostPerEntity	.00583	(Corr)	.00583	.00583	600
deblock.TotalTimePerEntity	5.8333E-04	(Corr)	5.8333E-04	5.8333E-04	600
flattness.TotalCostPerEntity	5.5556E-04	(Corr)	5.5556E-04	5.5556E-04	600
grilling.TotalCostPerEntity	.00139	(Corr)	.00139	.00139	600
unstick.waitCostPerEntity	.00000	.00000	.00000	.00000	600
cooling.NVATimePerEntity	.00500	(Corr)	.00500	.00500	600
unstick.NVACostPerEntity	.00111	(Corr)	.00111	.00111	600
cooling.TotalCostPerEntity	.00000	(Corr)	.00000	.00000	600
grilling.NVACostPerEntity	.00139	(Corr)	.00139	.00139	600
deblock.waitTimePerEntity	2.7778E-05	(Corr)	2.7778E-05	2.7778E-05	600
flattness.waitTimePerEntity	.00000	.00000	.00000	.00000	600
unstick.TotalCostPerEntity	.00111	(Corr)	.00111	.00111	600
grilling.waitTimePerEntity	1.4667E-04	(Corr)	.00000	3.3333E-04	600
platen.NVATimePerEntity	1.1111E-04	(Corr)	1.1111E-04	1.1111E-04	600
stamping.waitTimePerEntity	4.1667E-05	(Corr)	.00000	8.3333E-05	600
annealing.waitTimePerEntity	.23562	(Corr)	.00000	.51125	600
flattness.NVACostPerEntity	5.5556E-04	(Corr)	5.5556E-04	5.5556E-04	600
platen.waitCostPerEntity	.00000	.00000	.00000	.00000	600
stamping.TotalTimePerEntity	6.3444E-05	(Corr)	2.7778E-05	1.1111E-04	600
deblock.NVATimePerEntity	5.8333E-04	(Corr)	5.8333E-04	5.8333E-04	600
annealing.TotalCostPerEntity	.00000	(Corr)	.00000	.00000	600
annealing.NVACostPerEntity	.00000	(Corr)	.00000	.00000	600
platen.TotalCostPerEntity	.00111	(Corr)	.00111	.00111	600
flattness.TotalTimePerEntity	5.5556E-05	(Corr)	5.5556E-05	5.5556E-05	600
grilling.TotalTimePerEntity	3.0556E-04	(Corr)	1.3889E-04	4.7222E-04	600
unstick.waitTimePerEntity	.00000	.00000	.00000	.00000	600
unstick.NVATimePerEntity	1.1111E-04	(Corr)	1.1111E-04	1.1111E-04	600
cooling.NVATimePerEntity	.00500	(Corr)	.00500	.00500	600
cooling.TotalTimePerEntity	.00500	(Corr)	.00500	.00500	600
grilling.NVACostPerEntity	.00139	(Corr)	.00139	.00139	600
deblock.TotalTimePerEntity	1.3889E-04	(Corr)	1.3889E-04	1.3889E-04	600
stamping.NVACostPerEntity	.00583	(Corr)	.00583	.00583	600
flattness.TotalTimePerEntity	2.7778E-04	(Corr)	2.7778E-04	2.7778E-04	600
flattness.NVATimePerEntity	5.5556E-05	(Corr)	5.5556E-05	5.5556E-05	600
unstick.TotalTimePerEntity	1.1111E-04	(Corr)	1.1111E-04	1.1111E-04	600
Entity 1.NVATime	.00000	.00000	.00000	.00000	600
Entity 1.NVATime	.01103	(Corr)	.01103	.01103	600
Entity 1.waitTime	.21583	(Corr)	.00000	.51127	600
Entity 1.TransTime	.00000	.00000	.00000	.00000	600
Entity 1.OtherTime	.00000	.00000	.00000	.00000	600
Entity 1.TotalTime	.24686	(Corr)	.01103	.52769	600
Entity 1.VACost	.00000	.00000	.00000	.00000	600
Entity 1.NVACost	.11028	(Corr)	.11028	.11028	600
Entity 1.waitCost	.00000	.00000	.00000	.00000	600
Entity 1.TransCost	.00000	.00000	.00000	.00000	600
Entity 1.OtherCost	.00000	.00000	.00000	.00000	600
Entity 1.TotalCost	.11028	(Corr)	.11028	.11028	600
annealing.Queue.waitingTime	.21582	(Corr)	.00000	.51125	600
annealing.Queue.waitingCost	.00000	.00000	.00000	.00000	600

Figure 4.9. SIMAN results

4.6.2 Original layout results

Table 4.10 shows simulation results from the Arena software in the original layout in the studied company.

Table 4.10. Original layout simulation results

No	Item	Nilai Purata masa (min)
1	Stamping Expression	0.1
2	Piling Expression	0.5
3	Platen Expression	0.4
4	Annealing Expression	18.0
5	Cooling Expression	18.0
6	De' Block Expression	2.1
7	Flatness Expression	0.4
8	Un stick Expression	0.4
9	Stamping NVA time	0.002
10	Piling NVA time	0.008
11	Platen NVA time	0.006
12	Annealing NVA time	0.3
13	Cooling NVA time	0.3
14	De' Block NVA time	0.03
15	Flatness NVA time	0.003
16	Un stick NVA time	0.006
17	Stamping waiting	0.03
18	Piling waiting	0.01
19	Platen waiting	0
20	Annealing waiting	15
21	Cooling waiting	0
22	De' Block waiting	0
23	Flatness waiting	0
24	Un stick waiting	0
	Produk output	600

Based on the results on Table 4.10, the total number of products produced by the company (*blanking*) using the existing layout is 600 one piece per shift. There are three types of time listed in the table above, *expression*, *non value added* and wait time. The wait time in the process *annealing* is higher than the other process because it takes more than 7 hours for heating *hard disk*. Whereas for *cooling*, *De block*, *flatness* and *unstick processes*, no waiting time was recorded as the process network was continuous continuously. With the new layout, it is believed to reduce wait times while increasing output on each output.

4.6.3 Alternative layout results

The results in Table 4.11 show the differences between the three layouts simulated using Arena software. There is a significant difference between the expression values of the three layouts, *platen*, *annealing* and *cooling*. The differences in the input values are based on different distances for each layout. In addition, differences in values *expression* will also affect the output values to be generated. It can be seen that output is increasing in the second layout of 900 pieces per shift. This means that the shorter the time *expression* per process, the higher the output value can be generated. Table 4.11 shows the results through the arena analysis of the three tested layouts.

Table 4.11. Results of original layout and alternative layouts

No	Item	Value Time (min)		
		Current	Alternative 1	Alternative 2
1	<i>Stamping Expression</i>	0.1	0.1	0.1

2	<i>Piling Expression</i>	0.5	0.3	0.2
3	<i>Platen Expression</i>	0.4	0.3	0.2
4	<i>Annealing Expression</i>	18.0	13.0	9.0
5	<i>Cooling Expression</i>	18.0	13.0	10.0
6	<i>De 'Block Expression</i>	2.1	2.0	1.3
7	<i>Flatness Expression</i>	0.4	0.2	0.2
8	<i>Un stick Expression</i>	0.4	0.3	0.2
9	<i>Stamping NVA time</i>	0.002	0.0016	0.0017 Select
10	<i>NVA time</i>	0.008	0.005	0.003
11	<i>Platen NVA time</i>	0.006	0.005	0.003
12	<i>Annealing NVA time</i>	0.3	0.22	0.15
13	<i>Cooling NVA time</i>	0.3	0.22	0.16
14	<i>De 'Block NVA time</i>	0.03	0.03	0.022
15	<i>Flatness NVA time</i>	0.003	0.03	0.003
16	<i>Un stick NVA time</i>	0.006	0.005	0.006
17	<i>Stamping waiting time</i>	0.003	0.003	0.004
18	<i>Selected waiting time</i>	0.01	0.006	0.004
19	<i>Platen waiting time</i>	0	0	0
20	<i>Annealing waiting time</i>	15	6.63	0.3
21	<i>Cooling waiting time</i>	0	0	0
22	<i>De 'Block waiting time</i>	0	0	0
23	<i>Flatness waiting time</i>	0	0	0
24	<i>Un stick waiting time</i>	0	0	0
	Product output (pieces)	600	750	900

4.6.4 Output at each layout

Figure 4.10 and Figure 4.11 show the results of the Arena simulation of the first alternative layout where the final amount of output and the time involved in each process are displayed. Instead of Figures 4.12 and 4.13 are the results of the second alternative layout.

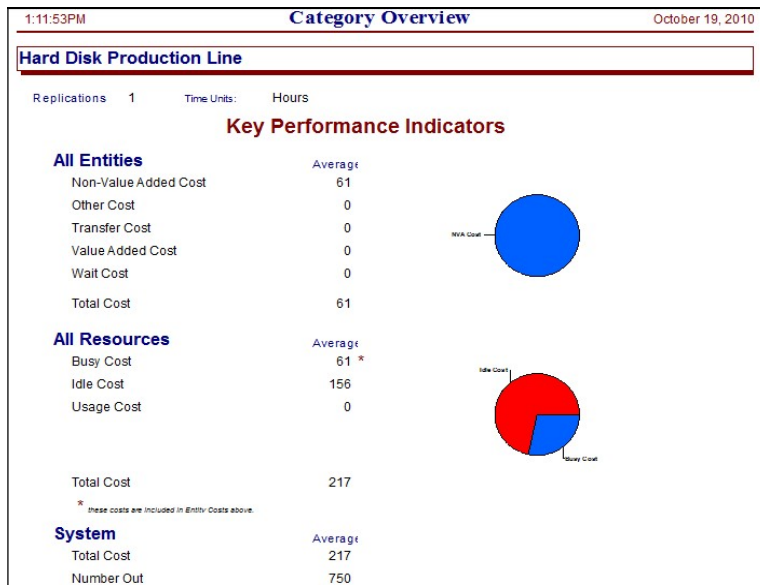
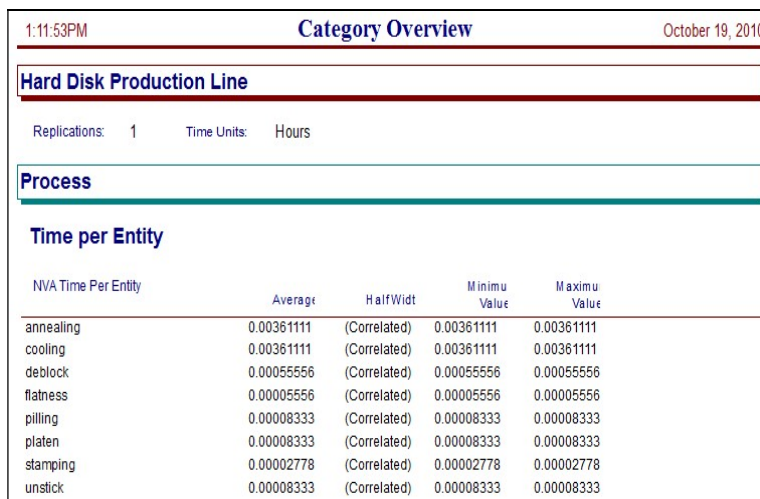

Figure 4.10. Performance indicators for alternative layouts 1



Wait Time Per Entity				
	Average	HalfWidth	Minimum Value	Maximum Value
annealing	0.1105	(Correlated)	0.00	0.2211
cooling	0.00	0.000000000	0.00	0.00
deblock	0.00	0.000000000	0.00	0.00
flatness	0.00	0.000000000	0.00	0.00
pillling	0.00011111	(Correlated)	0.00	0.00022222
platen	0.00	0.000000000	0.00	0.00
stamping	0.000055556	(Correlated)	0.00	0.00011111
unstick	0.00	0.000000000	0.00	0.00
Total Time Per Entity				
	Average	HalfWidth	Minimum Value	Maximum Value
annealing	0.1141	(Correlated)	0.00361111	0.2247
cooling	0.00361111	(Correlated)	0.00361111	0.00361111
deblock	0.00055556	(Correlated)	0.00055556	0.00055556
flatness	0.00055556	(Correlated)	0.00055556	0.00055556
pillling	0.00019444	(Correlated)	0.00008333	0.00030556
platen	0.00008333	(Correlated)	0.00008333	0.00008333
stamping	0.00008333	(Correlated)	0.00002778	0.00013889
unstick	0.00008333	(Correlated)	0.00008333	0.00008333

Figure 4.11. Time per process for alternative layouts 1

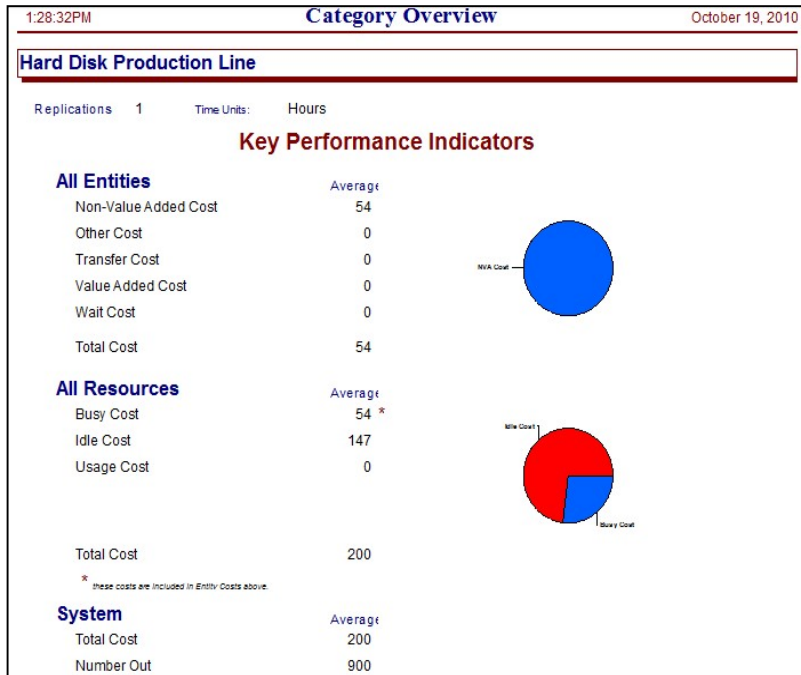

Figure 4.1 2. Performance indicators for alternative layout

2

1:28:32PM		Category Overview		October 19, 2010	
Hard Disk Production Line					
Replications: 1		Time Units: Hours			
Process					
Time per Entity					
NVA Time Per Entity					
	Average	HalfWidt	Minimu Value	Maximu Value	
annealing	0.00250000	(Correlated)	0.00250000	0.00250000	
cooling	0.00277778	(Correlated)	0.00277778	0.00277778	
deblock	0.00036111	(Correlated)	0.00036111	0.00036111	
flatness	0.00005556	(Correlated)	0.00005556	0.00005556	
pilling	0.00005556	(Correlated)	0.00005556	0.00005556	
platen	0.00005556	(Correlated)	0.00005556	0.00005556	
stamping	0.00002778	(Correlated)	0.00002778	0.00002778	
unstick	0.00011111	(Correlated)	0.00011111	0.00011111	
Wait Time Per Entity					
	Average	HalfWidt	Minimu Value	Maximu Value	
annealing	0.00611111	(Correlated)	0.00	0.01222222	
cooling	0.00069444	(Correlated)	0.00	0.00138889	
deblock	0.00	0.00000000	0.00	0.00	
flatness	0.00	0.00000000	0.00	0.00	
pilling	0.00006944	(Correlated)	0.00	0.00013889	
platen	0.00	0.00000000	0.00	0.00	
stamping	0.00006944	(Correlated)	0.00	0.00013889	
unstick	0.00	0.00000000	0.00	0.00	
Total Time Per Entity					
	Average	HalfWidt	Minimu Value	Maximu Value	
annealing	0.00861111	(Correlated)	0.00250000	0.01472222	
cooling	0.00347222	(Correlated)	0.00277778	0.00416667	
deblock	0.00036111	(Correlated)	0.00036111	0.00036111	
flatness	0.00005556	(Correlated)	0.00005556	0.00005556	
pilling	0.00012500	(Correlated)	0.00005556	0.00019444	
platen	0.00005556	(Correlated)	0.00005556	0.00005556	
stamping	0.00009722	(Correlated)	0.00002778	0.00016667	
unstick	0.00011111	(Correlated)	0.00011111	0.00011111	

Figure 4.13. Time per process for alternative layouts 2

4.7 Cycle Time Analysis

Based on data from Table 4.2 and Figure 4.3 cycle time for each process can be proved using the following formula.

$$\text{average cycle time} = \frac{\text{total time recorded by element}}{\text{number of element}} \times 60 \dots\dots(4.2)$$

i- Calculation of cycle time for the original layout

The following is a calculation of the cycle time for the original layout of each process involved.

1) Stamping:

$$\frac{198min}{kpg\ 12000} \times 60 = 0.99 \frac{s}{kpg}$$

2) Piling:

$$\frac{34.5min}{kpg\ 12000} \times 60 = 0.17 \frac{s}{kpg}$$

3) Platen:

$$\frac{185\ min}{12000kpg} \times 60 = 0.93 \frac{s}{kpg}$$

4) Annealing:

$$\frac{148\ min}{kpg\ 12000} \times 60 = 0.74 \frac{s}{kpg}$$

5) Cooling:

$$\frac{66\ min}{12000kpg} \times 60 = 0.3 \frac{s}{kpg}$$

6) De 'Block:

$$\frac{17\ min}{12000\ kpg} \times 60 = 0.09 \frac{s}{kpg}$$

7) Flatness:

$$1.85 + 2.4s + 3.5s + 3.0i + 24s = 34.7 \frac{s}{kpg}$$

8) Un-stick:

$$1.85 + 2.0s + 2.5s + 24s = 30.3 \frac{s}{kpg}$$

ii- Count cycle time for layout alternatives 1

1) Stamping:

$$\frac{198 \text{ min}}{15000 \text{ kpg}} \times 60 = 0.79 \frac{\text{s}}{\text{kpg}}$$

2) Piling:

$$\frac{34.3 \text{ min}}{15000 \text{ kpg}} \times 60 = 00:13 \frac{\text{s}}{\text{kpg}}$$

3) Platen:

$$\frac{185 \text{ min}}{15000 \text{ kpg}} \times 60 = 0.74 \frac{\text{s}}{\text{kpg}}$$

4) Annealing:

$$\frac{159 \text{ min}}{15000 \text{ kpg}} \times 60 = 0.64 \frac{\text{s}}{\text{kpg}}$$

5) Cooling:

$$\frac{61.2 \text{ min}}{15000 \text{ kpg}} \times 60 = 0.25 \frac{\text{s}}{\text{kpg}}$$

6) de 'Block:

$$\frac{17 \text{ min}}{15000 \text{ kpg}} \times 60 = 0.07 \frac{\text{s}}{\text{kpg}}$$

7) Flatness:

$$1.8\text{s} + 2.4\text{s} + 3.5\text{s} + 3.0\text{i} + 12\text{s} = 22.7 \frac{\text{s}}{\text{kpg}}$$

8) Un stick:

$$1.8\text{s} + 2.0\text{s} + 2.5 \text{ s} + 18 = 24.3 \frac{\text{s}}{\text{kpg}}$$

iii- Calculation of cycle time for layout alternatives 2

1) Stamping:

$$\frac{198 \text{ min}}{18000 \text{ kpg}} \times 60 = 0.6 \frac{\text{s}}{\text{kpg}}$$

2) Piling:

$$\frac{34.2 \text{ min}}{18000 \text{ kpg}} \times 60 = 0.11 \frac{\text{s}}{\text{kpg}}$$

3) Platen:

$$\frac{185 \text{ min}}{18000 \text{ kpg}} \times 60 = 0.6 \frac{\text{s}}{\text{kpg}}$$

4) Annealing:

$$\frac{147 \text{ min}}{18000 \text{ kpg}} \times 60 = 0.49 \frac{\text{s}}{\text{kpg}}$$

5) Cooling:

$$\frac{58.2 \text{ min}}{18000 \text{ kpg}} \times 60 = 0.2 \frac{\text{s}}{\text{kpg}}$$

6) De 'Block:

$$\frac{16 \text{ min}}{18000 \text{ kpg}} \times 60 = 0.05 \frac{\text{s}}{\text{kpg}}$$

7) Flatness:

$$1.8\text{s} + 2.4\text{s} + 3.5\text{s} + 3.0\text{i} + 12\text{s} = 22.7 \frac{\text{s}}{\text{kpg}}$$

8) Un stick:

$$1.8\text{s} + 2.0\text{s} + 2.5\text{s} + 12 = 18.3 \frac{\text{s}}{\text{kpg}}$$

Table 4.12. The cycle time differences among three layouts.

Process	Original layout (sec)	Alternative layout 1 (sec)	Alternative layout 2 (sec)
---------	-----------------------	----------------------------	----------------------------

<i>Stamping</i>	0.99	0.79	0.6
<i>Select</i>	0.17	0.13	0.11
<i>Platen</i>	0.93	0.74	0.6
<i>Annealing</i>	0.74	0.64	0.49
<i>Cooling</i>	0.3	0.25	0.2
<i>De'block</i>	0.09	0.07	0.05
<i>Flatness</i>	34.7	22.7	22.7
<i>Un-stick</i>	30.3	24.3	18.3
<i>Packing</i>	5.8	5.8	5.8
Total	74.02	55.42	48.85

Furthermore, Table 4.13 shows the difference in the total output that a blanking unit can produce in three layouts in a day, week, and month of operation. The number of employees in the blanking division is 20 people per shift.

Table 4.13: Output differences among three layouts

	Output / Day (pieces)	Output / Week (pieces)	Output / Month (pieces)
Original layout	24,000	168,000	720,000
Alternative layouts 1	30,000	210,000	900,000
Alternate layouts 2	36,000	252,000	1080,000

4.8 Suggestion

From the previous study, the proposal for a new layout to replace the old layout is a second alternative layout. This is based on the total cycle time obtained shorter than the other two layouts

of 48.85 seconds per *hard disk* compared to 74.02 seconds for the original layout and 55.42 seconds for the first alternative layout. Although the cycle time differences between these three layouts are not significant, they do have a significant impact on the company to increase output and subsequently manage its operating time wisely. The output generated by the blanking part increased by 360,000 pieces from 720,000 pieces making the overall value of the second alternative layout a total of 1080,000 pieces of *hard disk* per month.

4.9 Conclusion

At the end of this chapter it can be concluded that by increasing the distance between one machine and another, the time taken especially the operator's time becomes shorter. Saving time will bring double benefits to the company as more output can be produced in less time. However, this study is one of the experiments and will be recommended to the industry depending on the acceptance of the studied company itself. This is because the company need to take into account the costs involved in creating a new layout.

CHAPTER V

CONCLUSIONS OF THE STUDY

5.1 Introduction

This chapter discusses the conclusions of the overall results of the study. The conclusions of this study are based on the objectives of the study which are to study the cycle time of computer *hard disk* production process, to study and understand the flow of each process, and to evaluate and simulate using systematic layout planning (SLP) and Arena software.

5.2 Final Conclusions

Total cycle time (*blanking process*) at the studied company is 74.02 seconds per *hard disk*. The involved time in finding the cycle time is processing time, check time, waiting time, and delivery time. The cycle time according to the second alternative layout selected was 48.85s. Reducing cycle time is a good starting point for improving production operations. On the other hand, the longer cycle time may result in higher production costs as well as poor production. Reducing cycle time helps management find the exact time each process requires. Once the time has been reduced for unnecessary activity, the actual time allocated to that activity can be identified. In addition, the application of SLP (systematic layout planning) introduced by Richard Muther was successfully implemented to produce two alternative layouts for the proposal to replace the original layout in the blanking section.

There are 10 steps that have been implemented in the development of SLP, namely production activities, materials flow analysis, building charts, building the required space, building relationships between activities, identifying boundaries and boundaries, building alternative layouts and ultimately evaluating curves set it.

The use of Arena software is one of the evaluation methods to prove the comparison of data between the original layout and the selected alternative layout. As a result, the second alternative layout was chosen as the best solution to improve the existing layout in the section of *blanking*. A second alternative layout was proposed to the studied company as a new layout in order to reduce cycle time and to reduce *bottlenecks*, and as well to create a safe and a comfortable environment for employees.

REFERENCES

- Abdullah, M.Z, Bickerton, S., Bhattacharyya, D., and Crawford, R.J. 1909. *Rotational moding cycle time reduction using a physical techniques*. Polimer Engineering and Science.
- Azadivar, F., and Wang, J. 2000. Facility layout optimization using simulation and genetic algorithms. *International Journal of Production Research* **38(17)**: 4369-4383
- Canen, A.G., and Williamson, G.H. 1996. Facilities layout overview: towards competitive advantage. *Facilities* **14(10/11)**: 5-10
- Cardarelli, G., and Pelaggagge, P.J. 1995. Simulation tool for design and management optimization of automated interbay material handling and storage system for large wafer fab. *IEEE Transaction on Semiconductor Manufacturing*. **8(1)**: 4-49
- Henry, C. 2003. *Technology and Operation Management*. California Polytechnic and State University.
- Hicks, P.E. 1976. *Industrial Engineering and Management: A new perspective*. Arizona State University.
- James, R.E. 1997. *Production and Operation Management: Quality, Performance, and Value*. West Publishing Company.
- Meller, R.D., and Gau, K.Y., The facility layout problem: recent and emerging trenda and perspectives. *Journal of Manufacturing Systems*: 351-366.
- Mohd. Hezir Mohd. Amin. 2010. *Designing the systematic production system of herb product using Systematic Layout Planning approach*. Universiti Tun Hussein Onn Malaysia, Johor.
- Peters, B.A., and Yang, T. 1997. Integrated facilty layout and material handling system design in semiconductor fabrication facilities. *IEEE Transactions on Semiconductor Manufacturing* **10(3)**: 360-369.

Muther, R. 1973. *Systematic Layout Planning*. Second Edition.
Cahners Books. Boston.

PcMag Encyclopedia, Cycle Time Meaning. <http://www.pemag.com>.

Q-Finance, The ultimate financial resource, Finance Dictionary.
<http://www.qfinance.com>

ABOUT THE AUTHOR

Muhammad Marsudi is an Associate Professor in Mechanical Engineering, Faculty of Engineering, Universitas Islam Kalimantan MAB, Banjarmasin, Indonesia. He joined Universitas Islam Kalimantan MAB since 2015. He obtained his PhD in Mechanical Engineering from the National University of Malaysia, MSc in Computer Integrated Manufacturing & its Management from the University of Huddersfield (UK), and BSc in Mechanical Engineering from Gadjah Mada University, Indonesia. He started his career as a lecturer at Polytechnic of Banjarmasin (Indonesia) in 1989, and as a visiting lecturer on University Tun Hussein Onn Malaysia (UTHM) from 2006 until 2011. He joined King Abdulaziz University (Kingdom of Saudi Arabia) as Assistant Professor from 2011 until 2014. He has published journal and conference papers. His research interests include manufacturing system, simulation and modeling, optimization, quality control, and engineering management.

Published by:



UNIVERSITAS ISLAM KALIMANTAN
MUHAMMAD ARSYAD AL BANJARI

ISBN 978-623-7583-32-5



9 786237 583325